

Lautsprecher LSM-70A Art.-Nr.: 120100

Specification :

TYPE	UNIT	LSM-70A
Impedance	Ω	8 \pm 15%
Power (Nominal)	W	0.5
Power (Maximum)	W	1.0
Resonant Frequency	Hz	260 \pm 20%
Sound Pressure Level	dB	83 \pm 3
Frequency Range	Hz	Fo~12.000
Operating Temperature	$^{\circ}$ C	-20~+60
Storage Temperature	$^{\circ}$ C	-30~+70

Dimensions :

(Unit : mm)

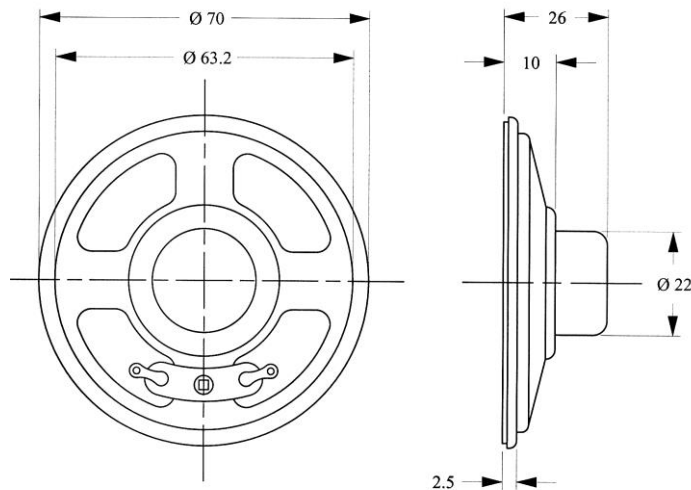

Frequency Response :

